

Poz.br.1

Radni sto DESNI PUNA NOGA + distancer
dim. 160/60-80/75

din. kom.4

INOX distanceri
presjeka $\frac{20}{20}$ mm

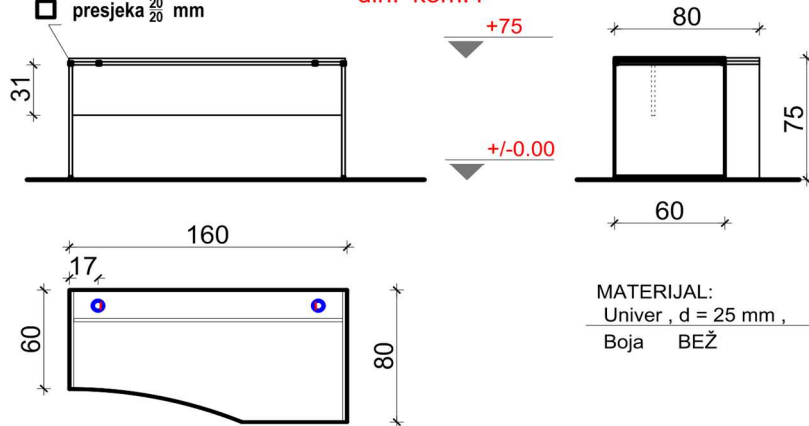

Poz.br.20

Radni sto, T noga LIJEVI
im. 160/60-80/75

kom.3

Poz.br.20*

Radni sto T noga DESNI
dim. 160/60-80/75

kom.3

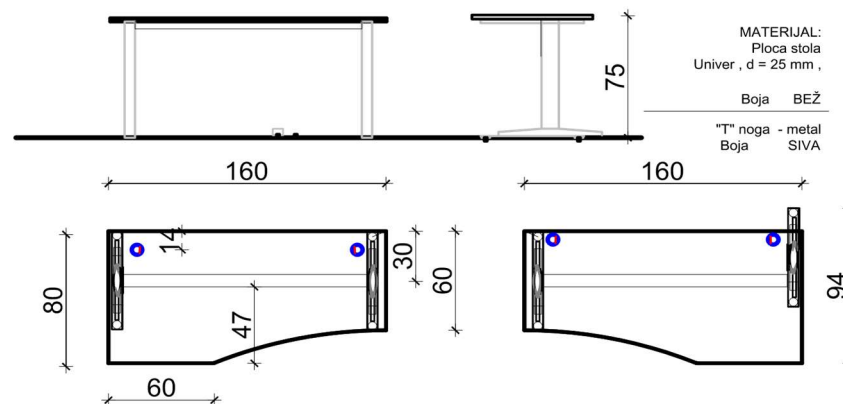

Poz. G

KLUB STO
kom.8

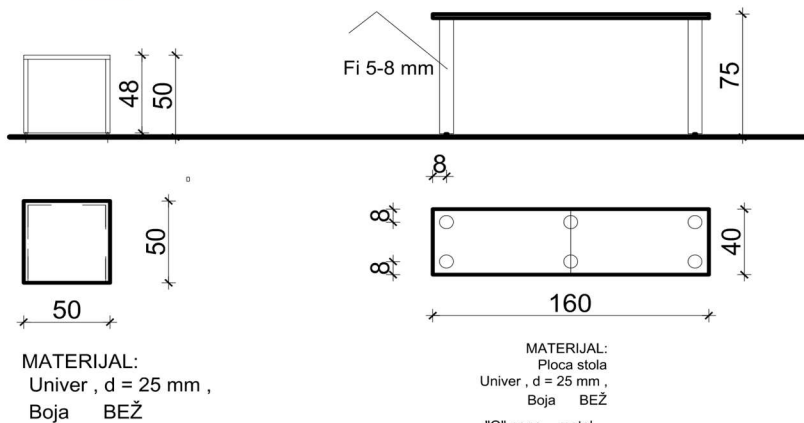

Poz.br.3.c.

Radni sto 160x40x75
U arhivi A3- o noga
kom.1

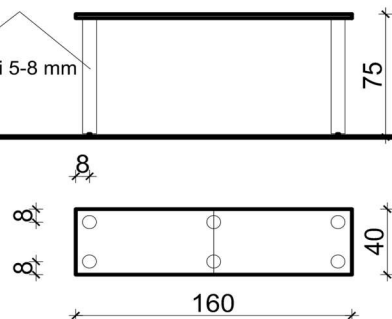

Poz.br.20.a.

Radni sto T noga LIJEVI
dim. 180/60-80/75

kom.1

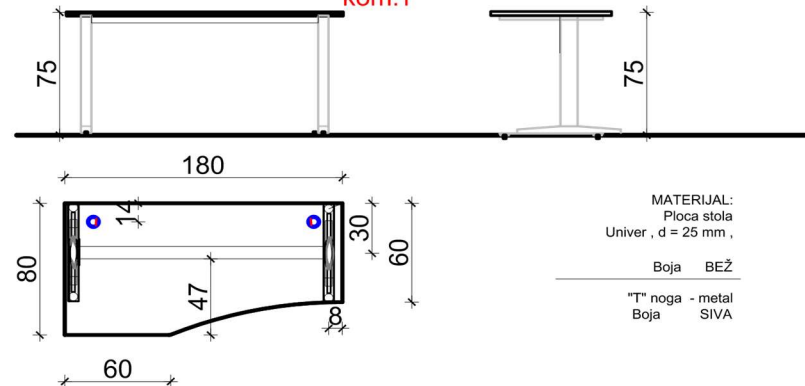

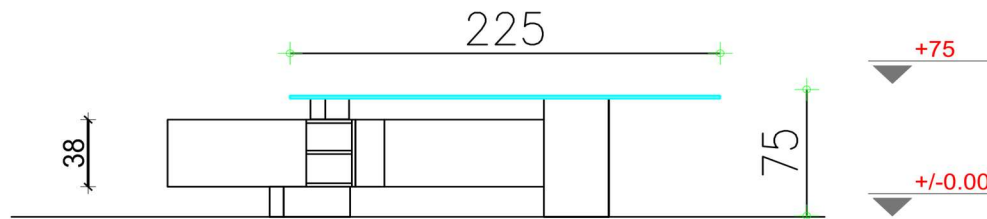

POZ. 22

RADNI STO LIJEVI
 sa komodom - ladice + police
 Kabinet Predsjednika Privrednog Suda
 Dim. 274 / 202 / 75
kom.1

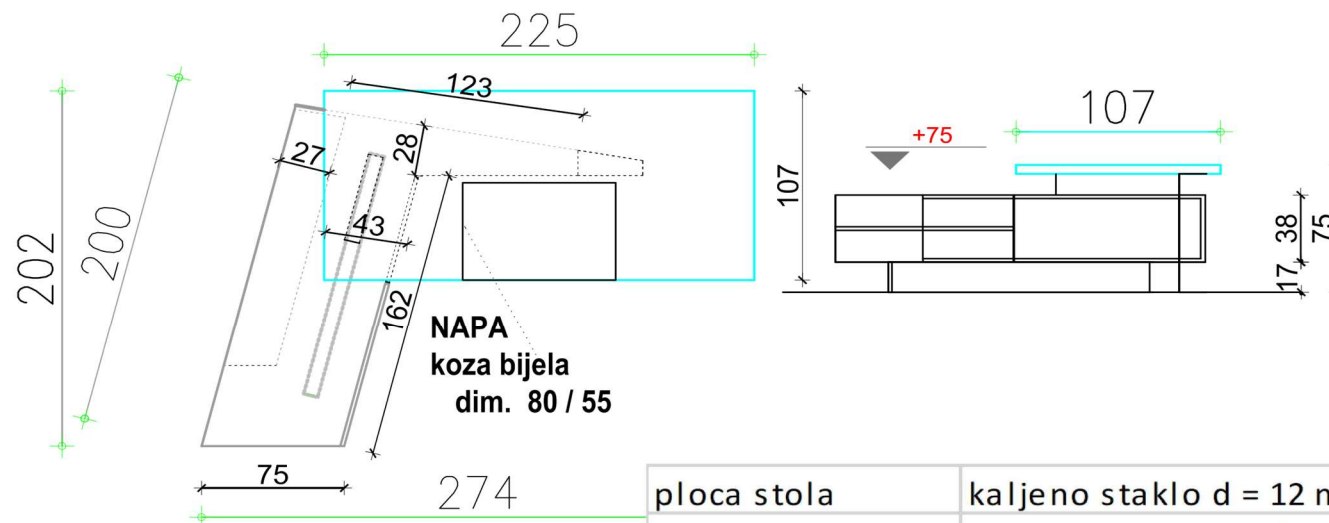

ploca stola	kaljeno staklo d = 12 mm + boja + film	
	kiselina protiv otiska prstiju , boja mliječna	
noga I komoda	MDF + P.U. lak , mat ,	
Boja - dekor	" mjesec sjaj " bijela RAL 9016	
Komoda	sa prednje strane = 4 ladice , otvaranje "P.T".	
	vrata + polica , otvaranje na "Push TOUCH "	
	sa vanjske strane , polica za knjige	

POZ. 28

Radni i konf. STO
za stranke u postupku
Sudije Privrednog Suda
Dim. 160 / 80 / 75

kom.3

POZ. 28a

Radni+Konf. STO
Sudije Privrednog Suda
Dim. 180 / 80 / 75

kom. 1

MATERIJAL

Ploca stola :
iverica + FURNIR dekor Orah - saten
Noge - elipticno oblikovan celicni profil ,
zaobljen na spojevima
Boja P.U.lak , Sivi , antracit Ral 7021
Sve na nivelirajucim stopicama

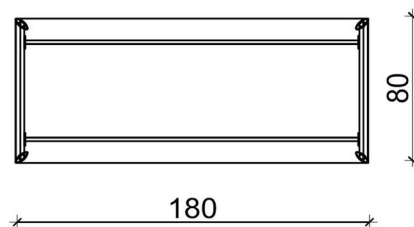
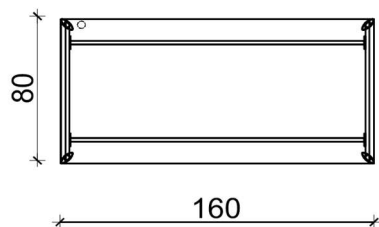
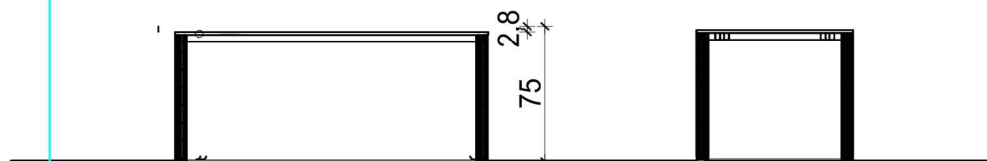

POZ. 29

Polukruzni STO
Sekretar O.P. Suda
Dim. 120 / 86 / 68

kom. 1

MATERIJAL

Ploca stola :
Iverica + FURNIR dekor Orah - saten
Noge - celicni profil ,fi 90 mm
plus tockovi sa kocnicom
Boja P.U.lak , Sivi , antracit Ral 7021
Sve na nivelirajucim stopicama

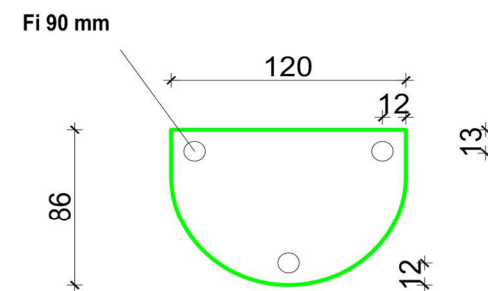
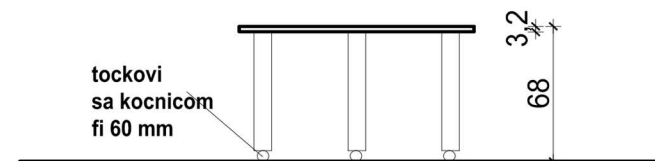

L.br.4

POZ. 31

Radni STO
Sekretar Pr. Suda
Dim. 180 / 80 / 75
KOM 1

MATERIJAL

Ploca i noga stola :
Iverica + FURNIR dekor Orah - saten
izmedju ploce i nogu distancer
od inox kvadratnog profila 20 / 20 mm
Sve na nivelirajucim stopicama

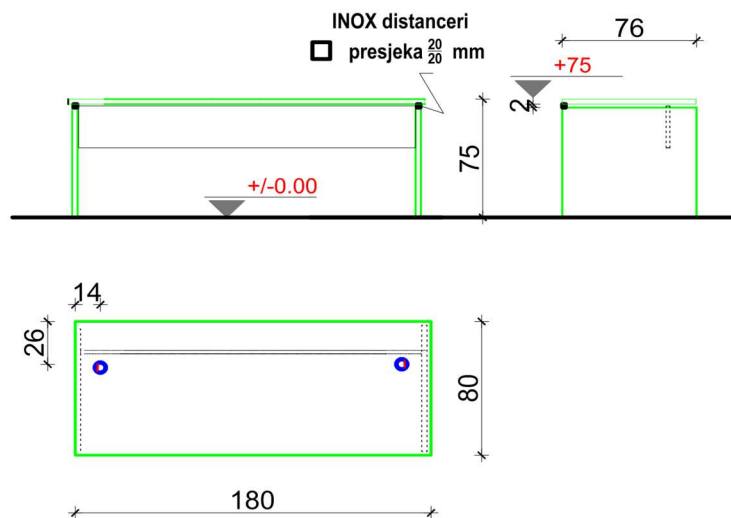

POZ. 34

Komoda sa ladicama
Kabinet Privrednog Suda
Dim. 240 / 55 / 67
kom. 1

MATERIJAL

Ploca i tijelo :
MDF + P.U. lak -dekor
'bijeli mjesec sjaj " Ral 9016
Fronte ladic : MDF + FURNIR - dekor :
"Orah satin"
ladice , klizaci besumni
otvaranje na pritisak dodirom
Postolje ispod poda komode
od trokutastih celicnih profila
Sve na nivelirajucim stopicama

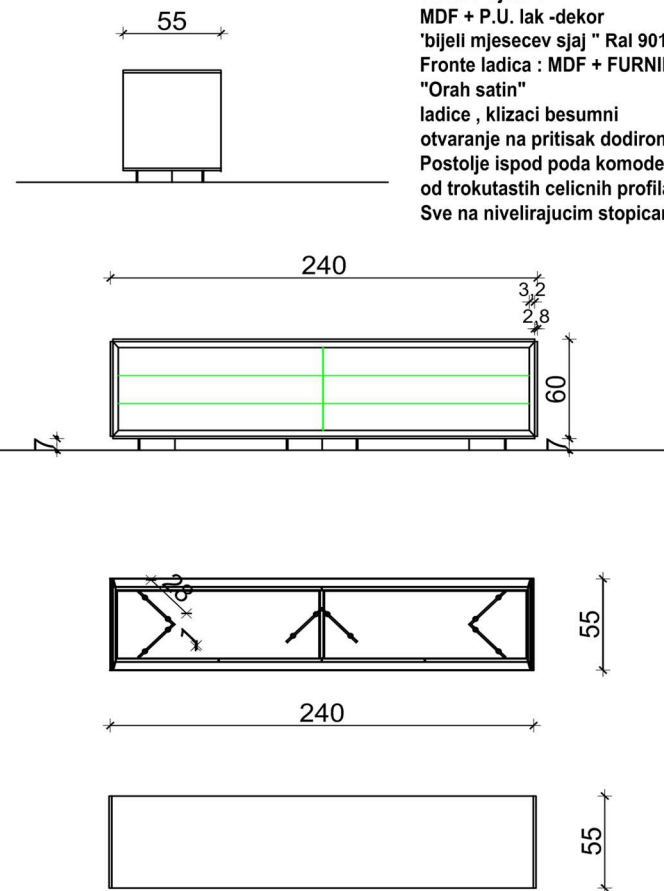

Bocne strane + podkonstrukcija - univer d 18 mm
 Ploca stola - Univer , d = 25 mm ;
 Boja Siva

MATERIJAL:

Putna policica - Kaljeno staklo d = 8 mm - pjeskareno sa donje strane
 Nosaci putne policice - inox fi 25 mm
 Nosaci staklene barijere - Inox Kvadratni profil 40x40, mm
 Staklena barijera - kaljeno providno staklo d = 4 mm

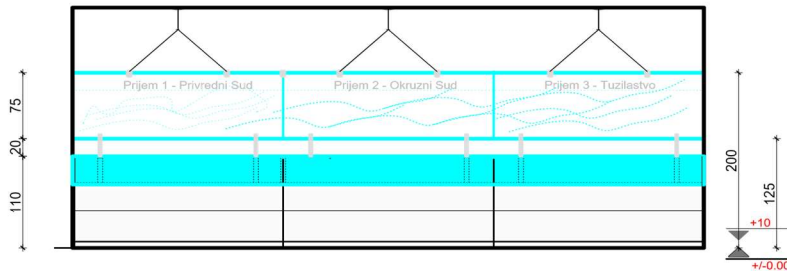
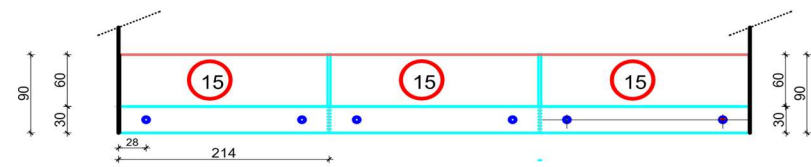
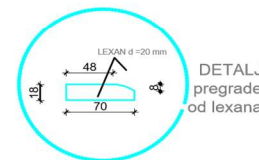
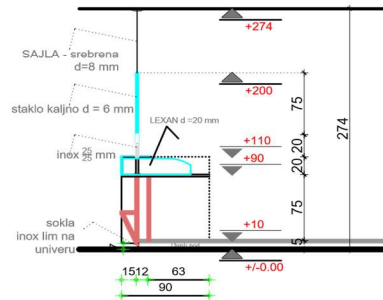
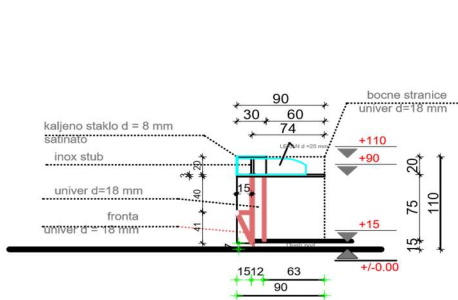

Poz.br.15
PULT + Radna ploha
 214/90/75 - 110
 PUNA NOGA
 kom. 3

Poz.br.4
 Radni sto
 dim. 2 x 168/70/75
 lijevi + desni
 PUNA NOGA
 komplet 1

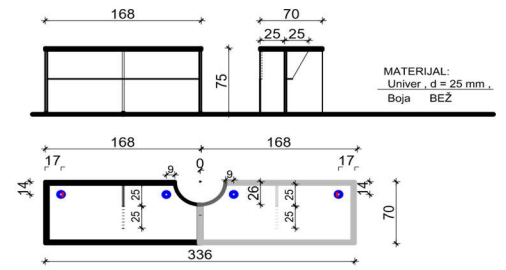

Poz.br.13
 PULT - Sto za pisanje za stranke
 200/50/105
 PUNA NOGA
 kom. 1

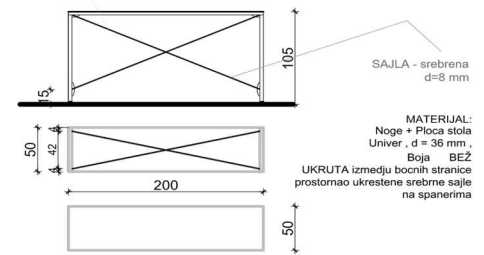

Poz.br.14
 Radni sto za Advokata
 167/50/75
 PUNA NOGA
 kom. 1

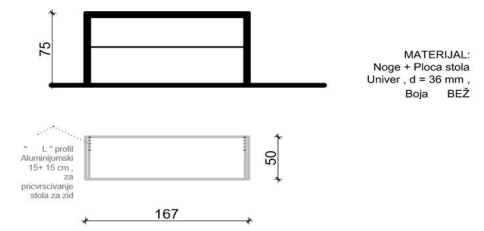

POZ. 36

ORMAR - garderobni

Dim. 100 / 46 / 180

kom. 4

MATERIJAL:
Univer , d = 18 mm ,
Ledja - Lesomal 5 mm
Boja BEŽ

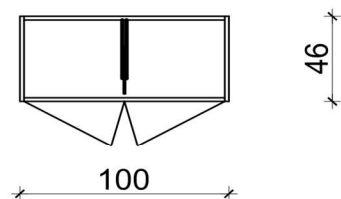
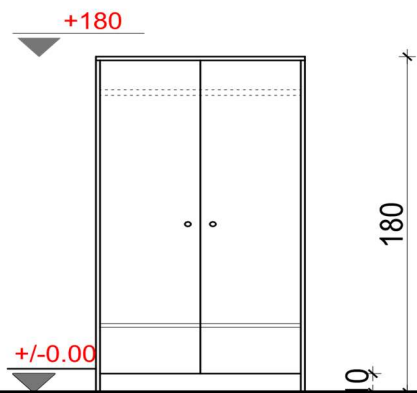
**POZ. 37**

ORMAR - arhivski

Dim. 100 / 46 / 180

kom. 4

MATERIJAL:
Univer , d = 18 mm ,
Ledja - Lesomal 5 mm
Boja BEŽ

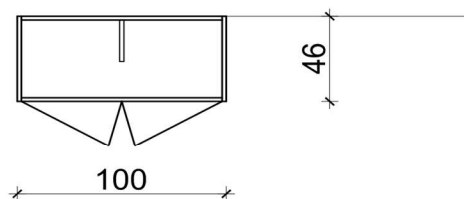
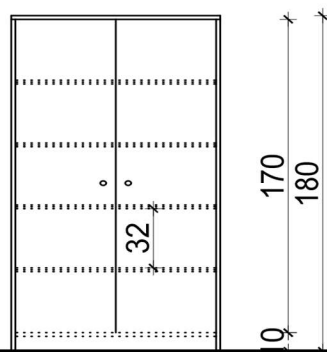
**POZ. 36a**

ORMAR - garderobni

klizna vrata

Dim. 100 / 46 / 180

kom. 1

MATERIJAL:
Univer , d = 18 mm ,
Ledja - Lesomal 5 mm
Boja BEŽ

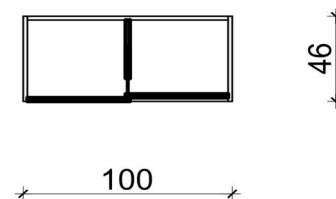
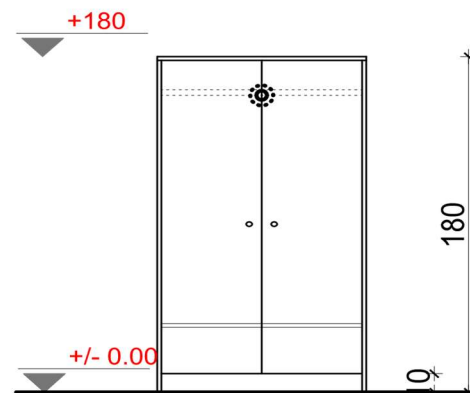
**POZ. 37a**

ORMAR - administrativni

klizna vrata

Dim. 100 / 46 / 180

kom. 1

MATERIJAL:
Univer , d = 18 mm ,
Ledja - Lesomal 5 mm
Boja BEŽ

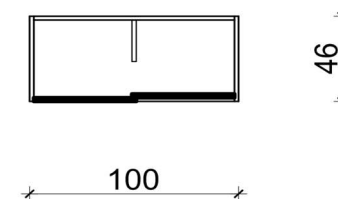
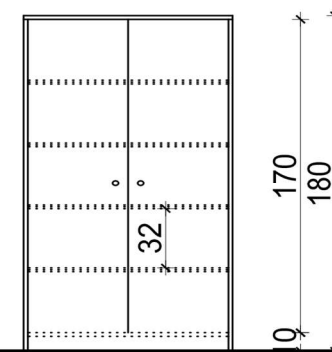

POZ. 38
ORMAR - arhivski
 Dim. 100 / 46 / 180
kom. 5

POZ. 51
ORMAR-arh.-kl. vrata
 Dim. 120 / 46 / 180
kom.1

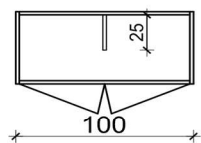
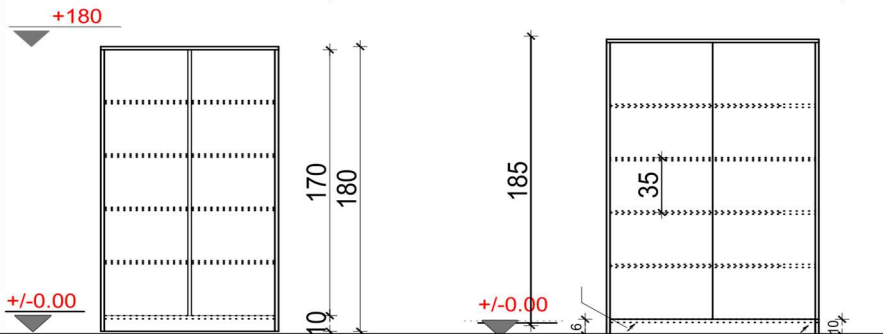
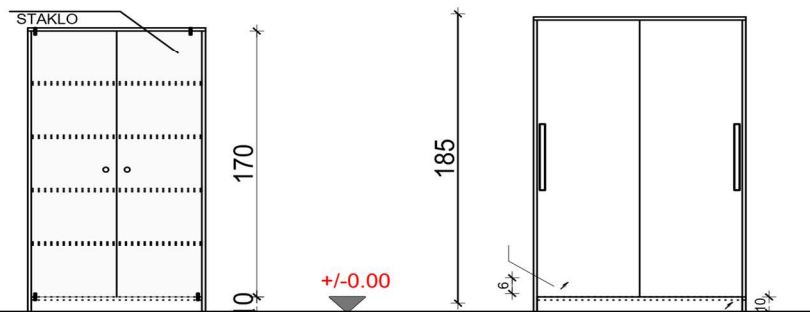

MATERIJAL:
 Univer , d = 18 mm
 vrata " satinato " staklo ,
 "baglame" = trn oko
 vertikalne osi
 Ledja - Lesomal 5 mm
 Boja BEŽ

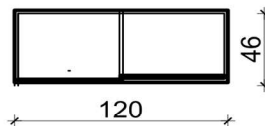

MATERIJAL:
 Univer , d = 18 mm ,
 Ledja - Lesomal 5 mm
 Rucke - Alum. lajsne duz visine
 Bravica na sokli
 Boja BEŽ

POZ. 52*
ORMAR - I.T.
 Gard + adm.arhiva
 klizna vrata
 Dim. 120 / 46 / 300
kom.1

POZ. 52
ORMAR - I.T.
 admin. arh + ostava
 klizna vrata
 Dim. 120 / 46 / 300
kom.2

MATERIJAL:
 Univer , d = 18 mm ,
 Ledja - Lesomal 5 mm
 Rucke - Alum. lajsne duz visine
 Bravica na sokli
 Boja BEŽ

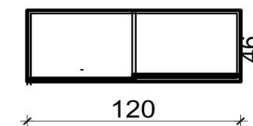
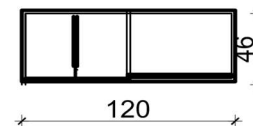
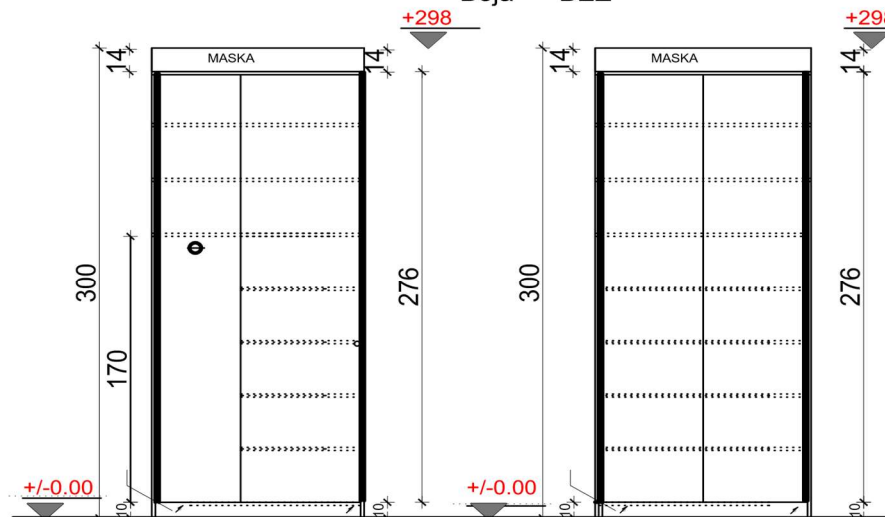

POZ. 53a

ORMAR - arhivski
otklopna vrata
Dim. 102 / 45 / 164.5

kom. 3

MATERIJAL:
Iverica + melamin ,
d = 16+10 mm ,
Ledja - Lesomal 10 mm
Rucke - Alum.
Bravica na vratima
Boja BEŽ



POZ. / RO

Ormar -arhivski
ROLO VRATA
Dim 120/45/200

kom. 2

MATERIJAL:
Metal , sivi
Tijelo 1,3 mm
vrtaa PVC lamela
police 1mm, h = 39mm
Bravica + ključ

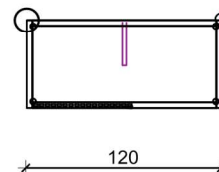
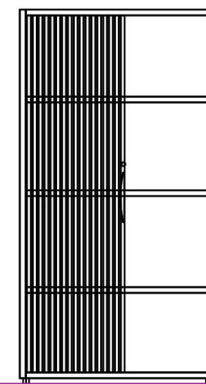
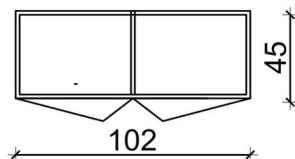
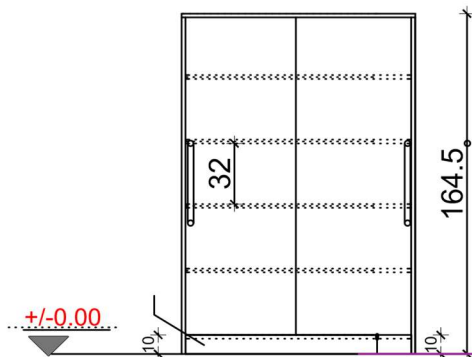

POZ. 53b

ORMAR -KOMODA
arhivski
otklopna vrata
Dim. 200 / 46 / 100
kom.1

MATERIJAL:
Univer ,
d = 16+10 mm ,
Ledja - Lesomal 10 mm
Rucke - Alum.
Bravica na vratima
Boja BEŽ

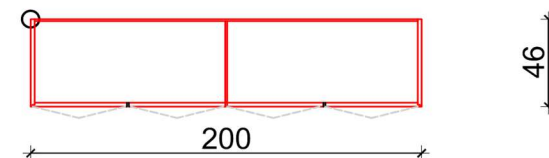
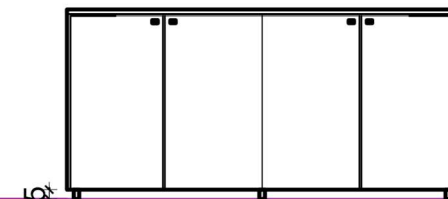

POZ. pk1.

podkonstrukcija
celicna 40/40mm
Dim. 80 / 40 / 14
kom. 34

MATERIJAL:
Celicni profil
kvadratni 40/40 mm
Boja BEŽ

POZ. 43

POLICE jednostuke
Dim. 80 / 40 / 260
kom. 34

MATERIJAL:
Univer, d = 18 mm,
Ledja - Lesomal 5 mm
Boja BEŽ

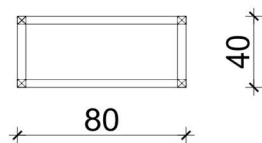
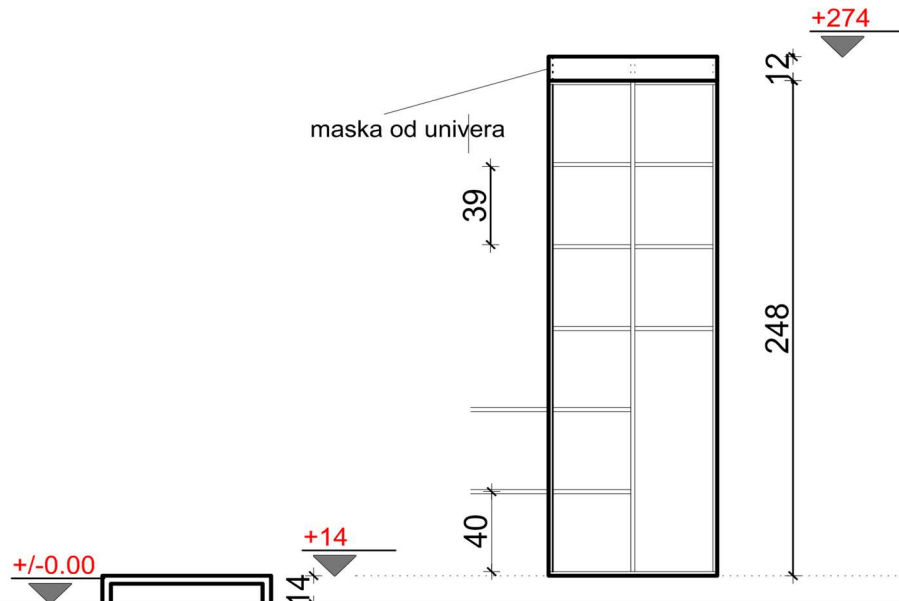

MATERIJAL:
celicni profil 40/40 mm

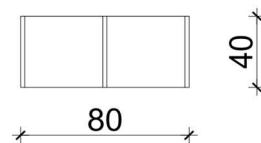

M 1:25

List br. 37

POZ. pk 2.

podkonstrukcija
celicna 40/40mm
Dim. 80 / 80 / 14
kom. 18

MATERIJAL:
Celicni profil
kvadratni 40/40 mm
Boja BEŽ

POZ. 44

POLICE dvostruke
Dim. 80 / 80 / 260
kom. 18

MATERIJAL:
Univer, d = 18 mm,
Ledja - univer d 18 mm
Boja BEŽ

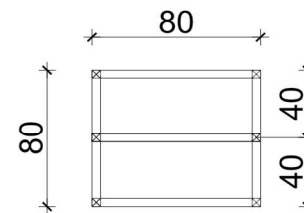
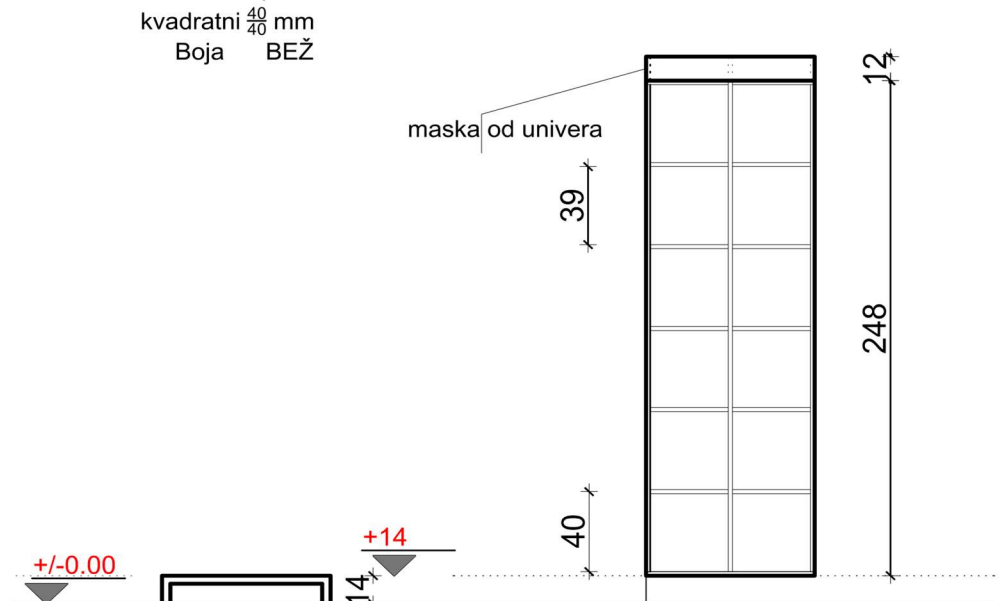

MATERIJAL:
celicni profil 40/40 mm

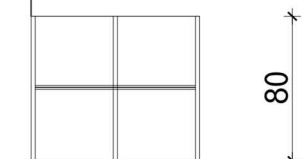

M 1:25

List br. 10

POZ. 57

Ormar
San.cvor 1,
dim. 100/46/200
kom. 1

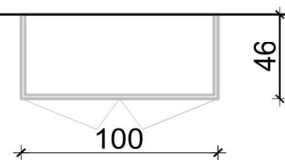
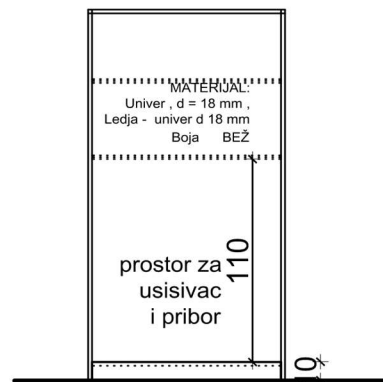
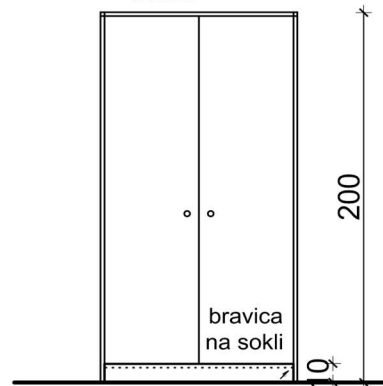

POZ. P.P

Pultna polica ,
Vjetrobran= Portir
Dim 2 x 142 / 24 / 110
KPL. 1

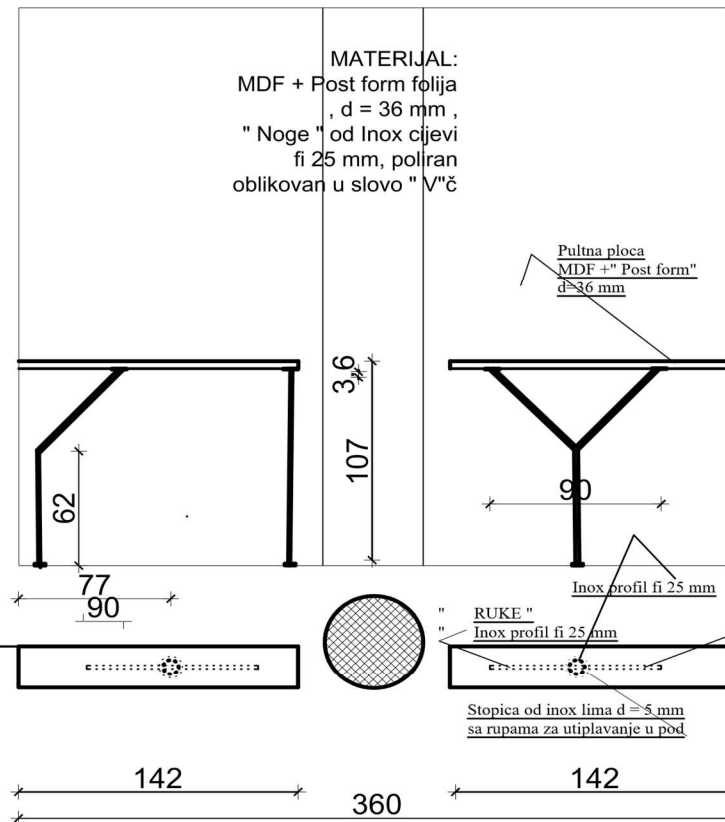

POZ. V.

Ormar od univera
Vrata od MDF+ boja
Dim. 60/2/220
kom. 1

MATERIJAL:
Univer , d = 18 mm ,
Ledja - Lesomal 5 mm
Vrata - MDF 18
+ boja kao na zidu

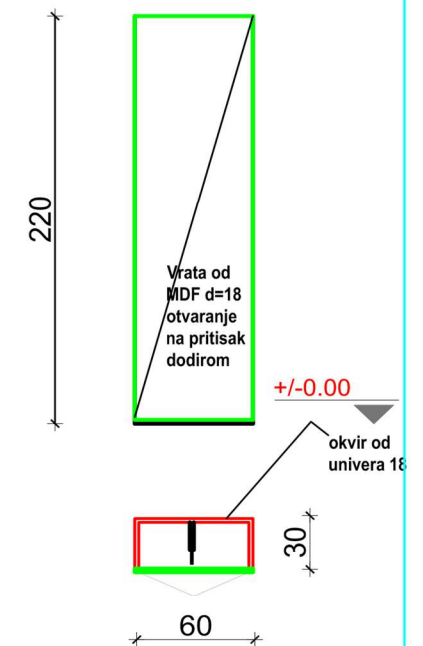

POZ. 54

ORMAR - PRIJEM za O.Privredni + Okruzni Sud
Ormar sa pretincima +gard. dio - klizna vrata
Dim. 215 / 46 /187

gard. 2

POZ. 54a

ORMAR - PRIJEM za Tuzilastvo
Ormar sa policama + gard - klizna vrata
Dim. 215 / 46 /187

kom. 1

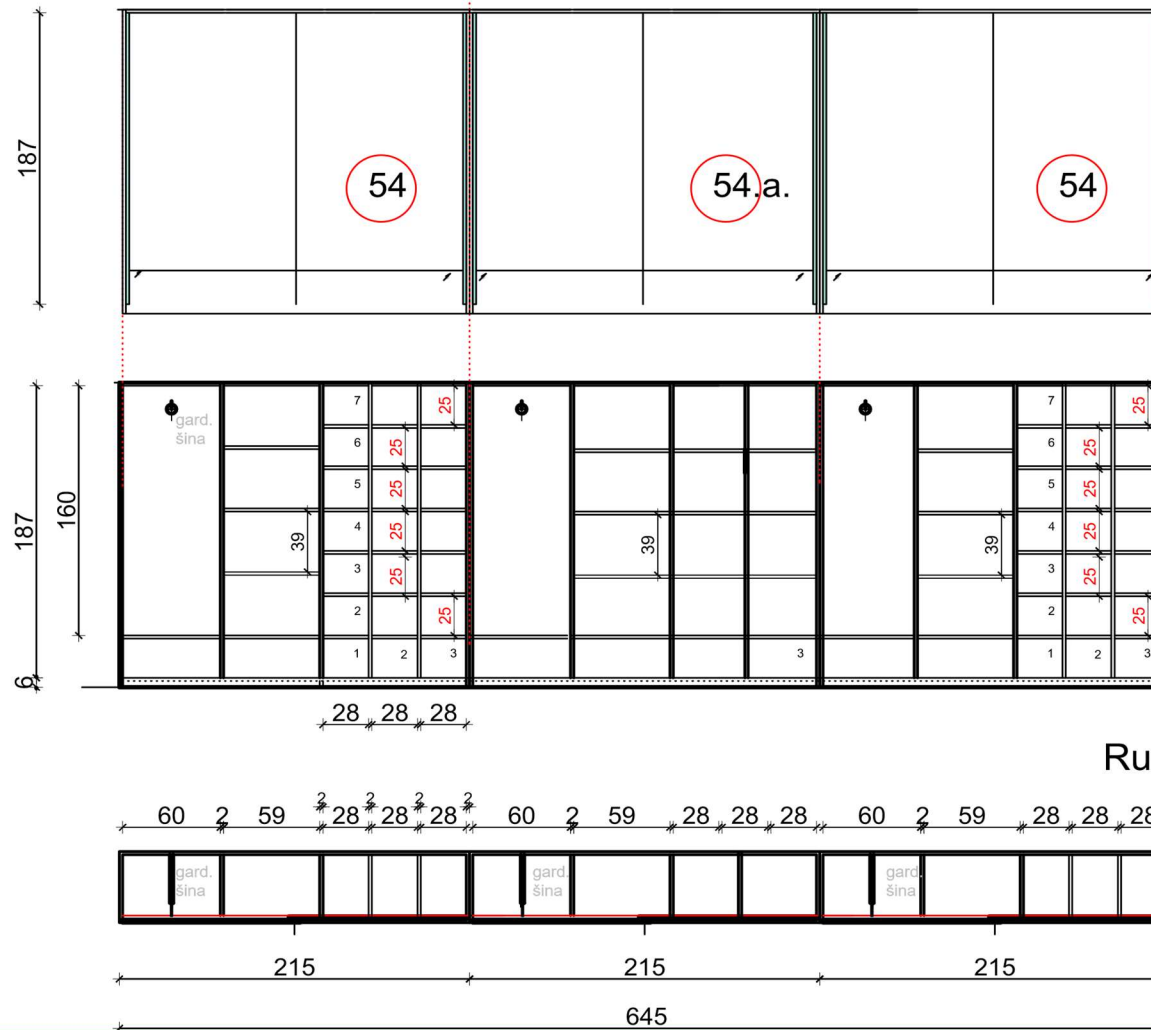

MATERIJAL:
 Univer , d = 18 mm ,
 Ledja - Lesomal 5 mm
 Rucke - Alum. lajsne duz visine
 Bravica na sokli
 Boja BEŽ

POZ. 55

**ORMAR - Pisarnica za predmete
klizna vrata
Dim. 80 / 46 / 300**

kom.3

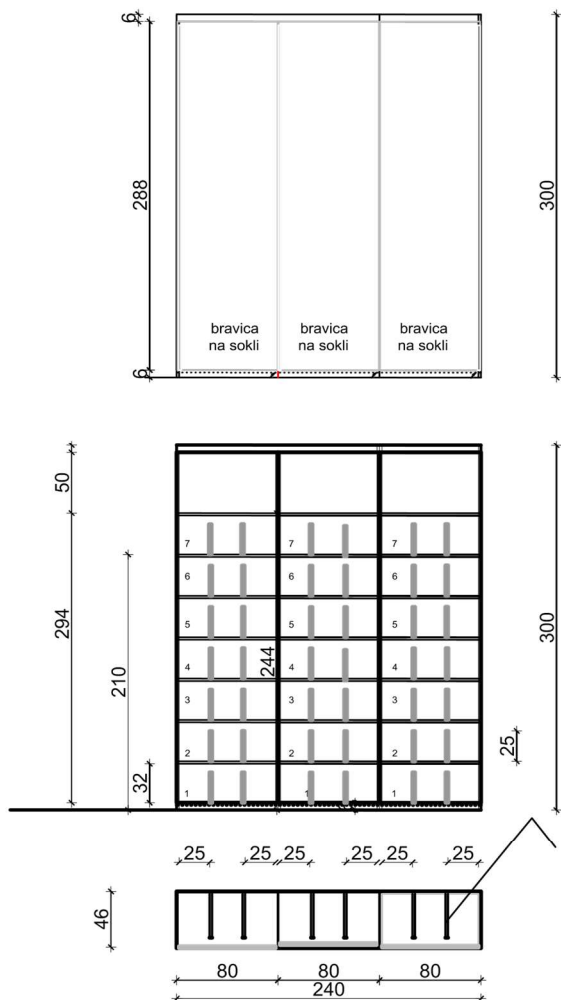

POZ. 55 a

**ORMAR - Pisarnica za predmete i za Sudije
klizna vrata
Dim. 160 / 46 / 300**

kom. 1

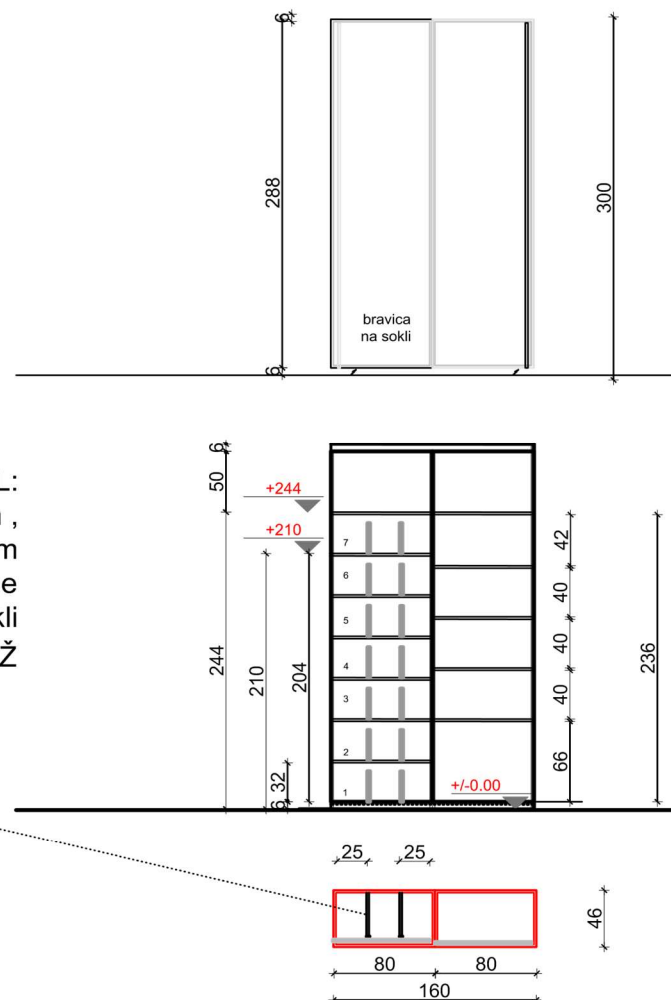

MATERIJAL:
Univer , d = 18 mm ,
Ledja - Lesomal 5 mm
Rucke - Alum. lajsne duz visine
Bravica na sokli
Boja BEŽ

POZ. 55 b
ORMAR - za administraciju - klizna vrata
Dim. 160 / 46 / 300
kom. 2

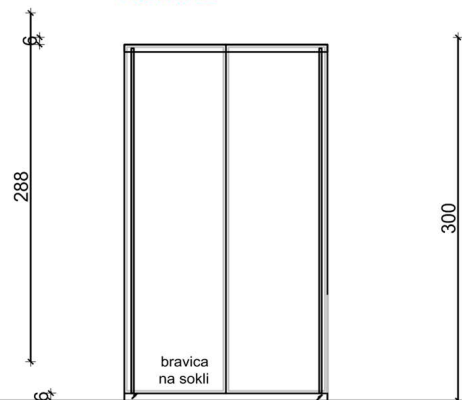

POZ. 55c
ORMAR - za predmete u Pisarnici i za Sudije
klizna vrata
Dim. 160 / 46 / 300
kom.1

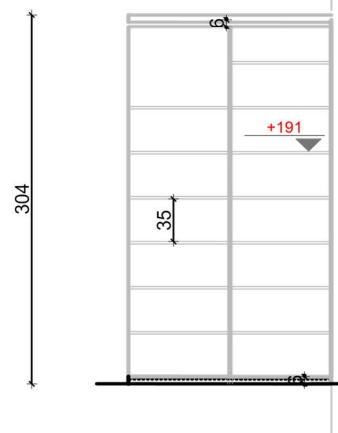
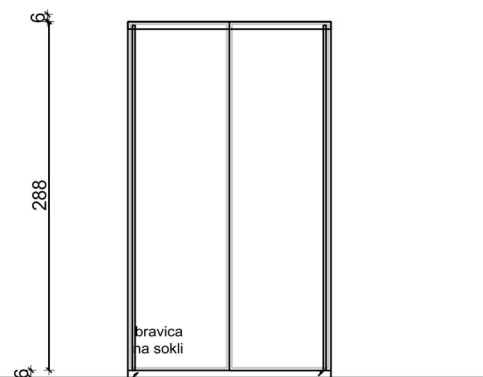

MATERIJAL:
Univer , d = 18 mm ,
Ledja - Lesomal 5 mm
Rucke - Alum. lajsne duz visine
Bravica na sokli
Boja BEŽ

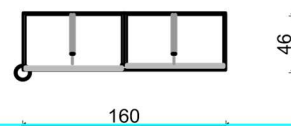
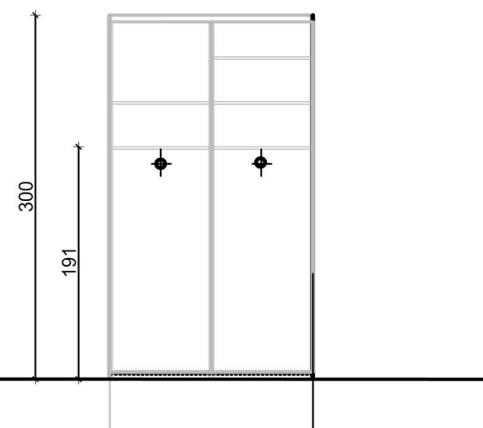

Poz. br. Y*

Ladicar ,fiksni
bravica + kljuc
Vel. 42/52/ 72
kom.16

PRESJEK 1-1

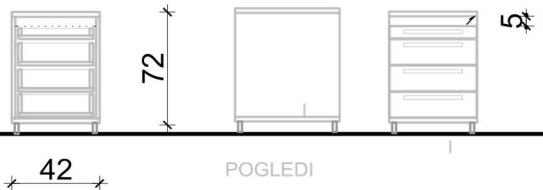

POGLEDI

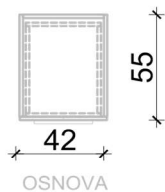

MATERIJAL:
Ladicar
Univer d = 18 mm
vodilice besumne
sa zaustavljanjem
centralna bravica
za sve ladice
Boja BEŽ

Poz. br. Y

Ladicar ,pokretni
bravica + kljuc
Vel. 42/52/55
kom . 4

PRESJEK 1-1

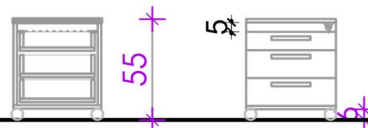

OSNOVA

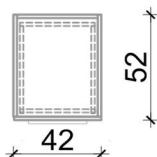

MATERIJAL:
Ladicar
Univer d = 18 mm
vodilice besumne
sa zaustavljanjem
centralna bravica
za sve ladice
Boja BEŽ

Poz. br. Z*

Komoda
sa Ladicama DESNA
bravica + kljuc
Vel. 110/55/ 55
kom 1

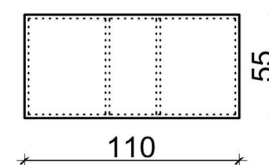
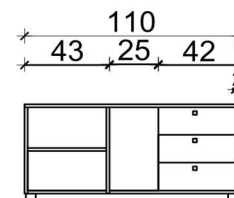

MATERIJAL:
Ladicar
Univer d = 18 mm
vodilice besumne
sa zaustavljanjem
centralna bravica
za sve ladice
Boja BEŽ

Poz.br.A

Poklopna ploca iznad ladicara 60/60/2.5

kom.7

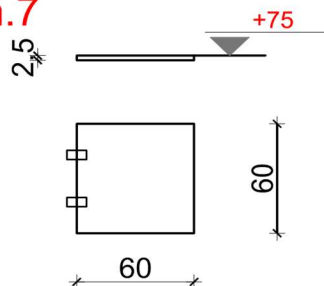

MATERIJAL:
Univer, d = 25 mm,
Boja BEŽ

Poz.br.D

Bocna stranica ispod pokl. ploce

Dim. 60/70/2.5

kom.4

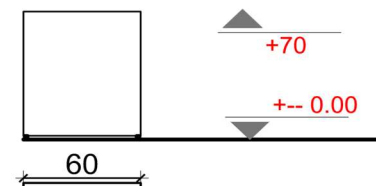

MATERIJAL:
Univer, d = 25 mm,
ABS kant 2 mm
Boja BEŽ

Poz.br.B

Poklopna ploca iznad ladicara 100/60/2.5

kom.4

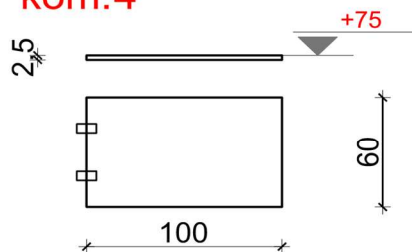

MATERIJAL:
Univer, d = 25 mm,
Boja BEŽ

Poz.br.C

Poklopna ploca iznad ladicara 140 /60/2.5

kom.2

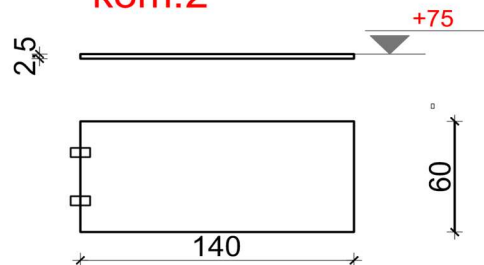

MATERIJAL:
Univer, d = 25 mm,
Boja BEŽ

POZ. O.6.
Obloga zida iza stolica
razne kancelarije
dim. 90/20/2

kom. 5

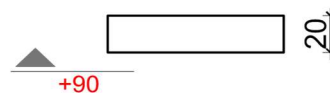

MATERIJAL:
Univer d = 18 mm
Boja BEŽ

POZ. P.
Pregrada u pisarnici
Dim. 200 / 5 / 140 cm
kom. 1

Al. profil
50 mm



Satinato staklo d = 6 mm

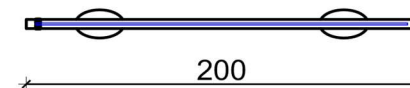

MATERIJAL:
okvir = Al profil 50 mm
Ispuna je od satinato
stakla d = 6 mm

275/60/85+275/30/64

105 / 70 / 85
160 / 35 / 110

POZ. K kpl. 1
Kuhinja : donji + gornji dio ,
dim. 275 / 60 / 85 + 275 / 30 / 64

POZ. K 1 kom. 1

POZ. K 2 kom. 1

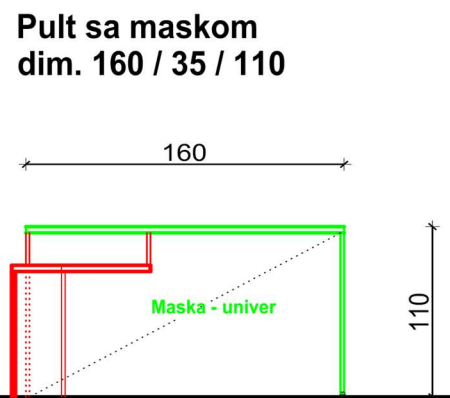
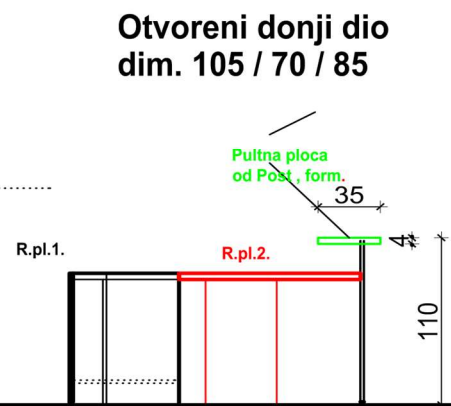
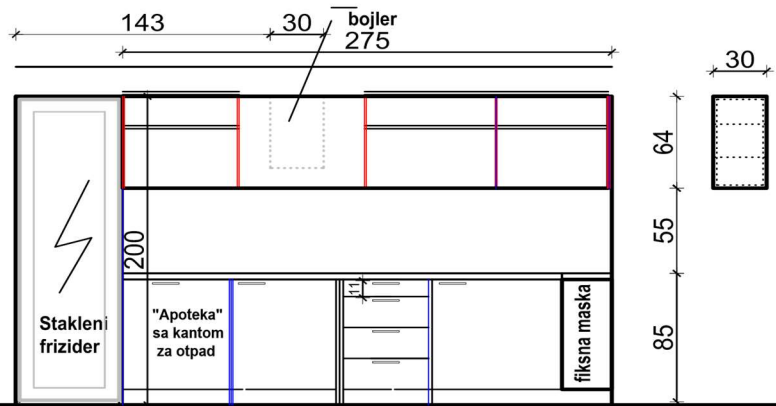

Pogled A

Pogled B

Pogled C

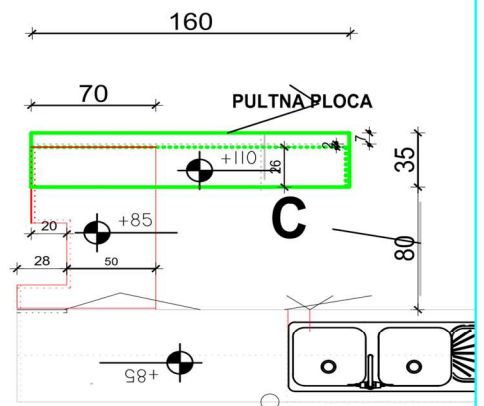
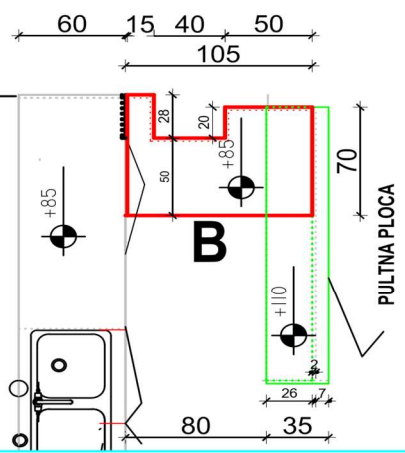
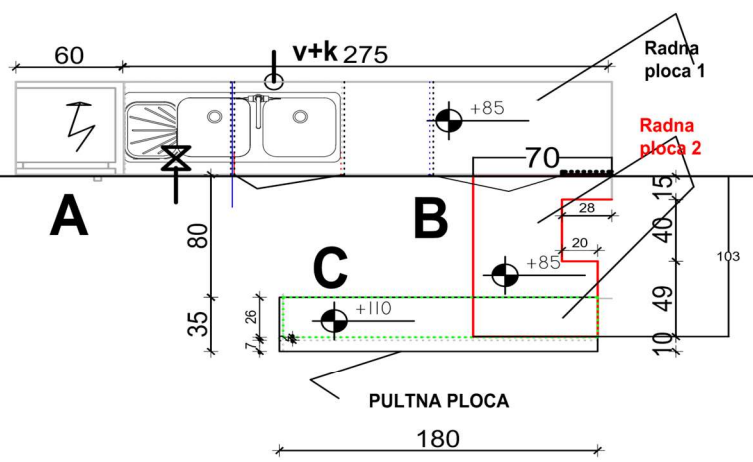

MATERIJAL:
Ploca i pult:
MDF + P.F. d = 36 mm
Univer, d = 18 mm,
Boja BEŽ